

SEWING MACHINE TABLE
COMFORT 7 (C 7+)
СТОЛ ДЛЯ ШВЕЙНОЙ МАШИНЫ



SYMBOLS



ATTENTION

ВНИМАНИЕ



ASSEMBLY & ADJUSTMENT

СБОРКА РЕГУЛИРОВКА



OPERATION

ЭКСПЛУАТАЦИЯ

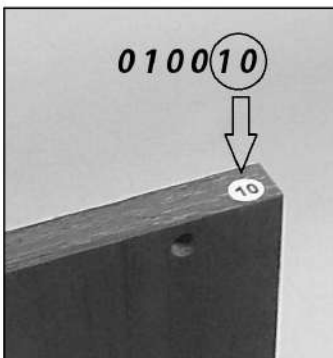

INDICATING MARK

ОБОЗНАЧЕНИЕ

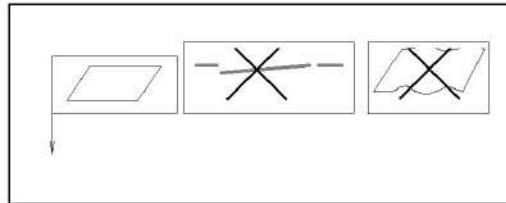



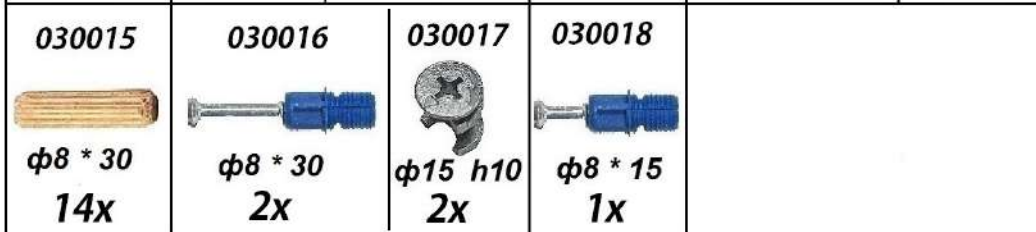
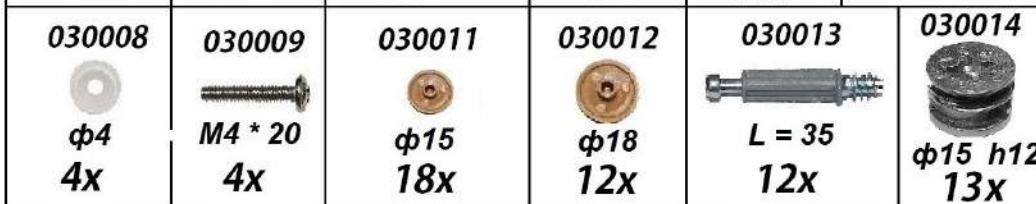
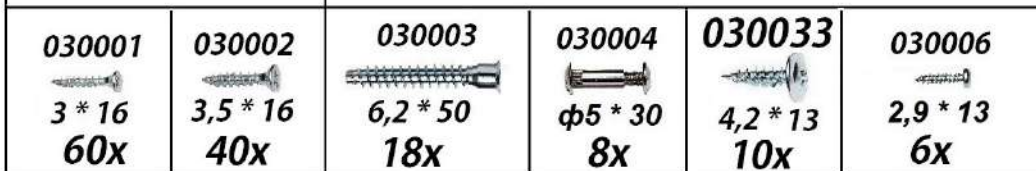
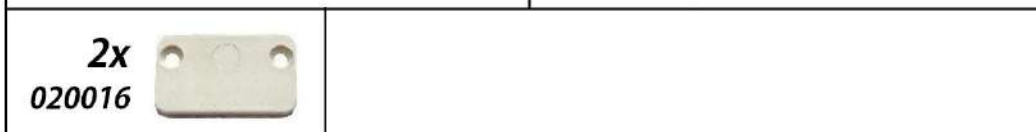
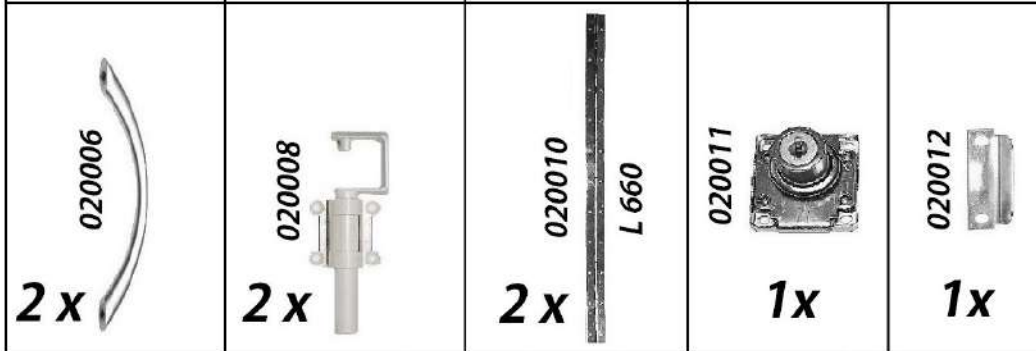
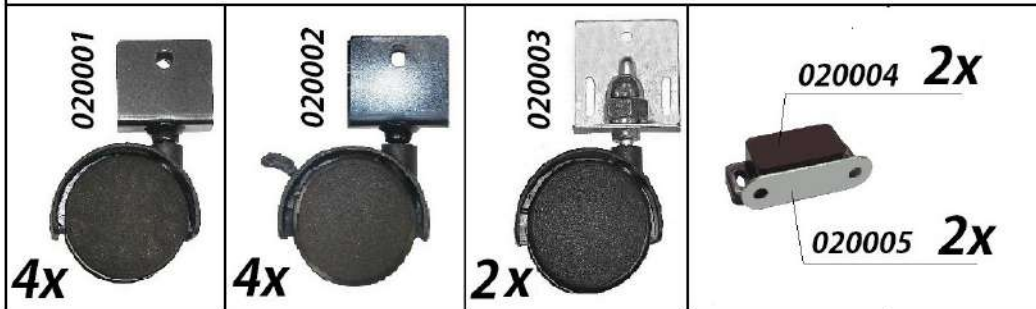

EVEN SURFACE

РОВНАЯ ПОВЕРХНОСТЬ

010001 1x	010002 1x	010003 1x	010004 1x
010006 1x	010007 1x	010008 1x	010010 1x
010011 1x	010012 1x	010013 1x	010015 1x
010023 1x	010024 1x	010025 1x	010026 1x
010027 1x	010028 1x	010030 1x	010031 1x
010032 1x			

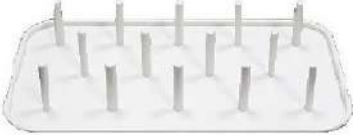

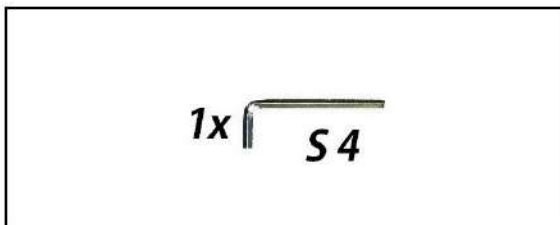

<p>1 x 050001</p> 	<p>1 x 050002</p> 
<p>1x 050004</p> 	<p>1 x 050003</p>  <p>2x 050005</p> 

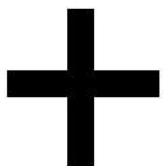

COMFORT 7+



<p>010018 1x</p> <p>010019 1x</p>	<p>020001</p> 	<p>5x 020019</p> 	<p>030004</p>  <p>$\phi 5 * 30$</p> <p>1x</p>	<p>030033</p>  <p>4,2 * 13</p> <p>20x</p>
---	--	--	---	---

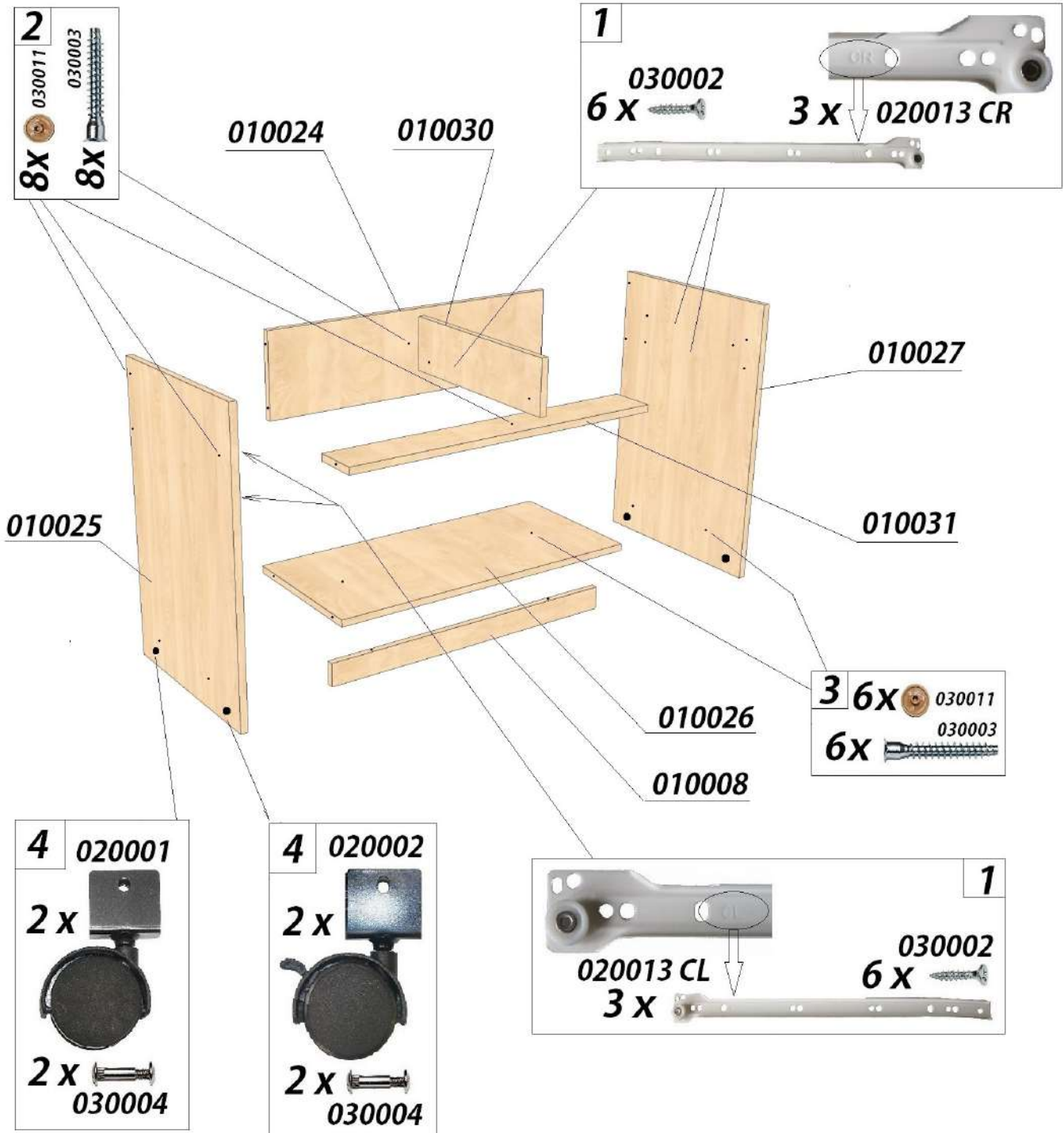

*
Входит в комплект стола.
Included into table set.

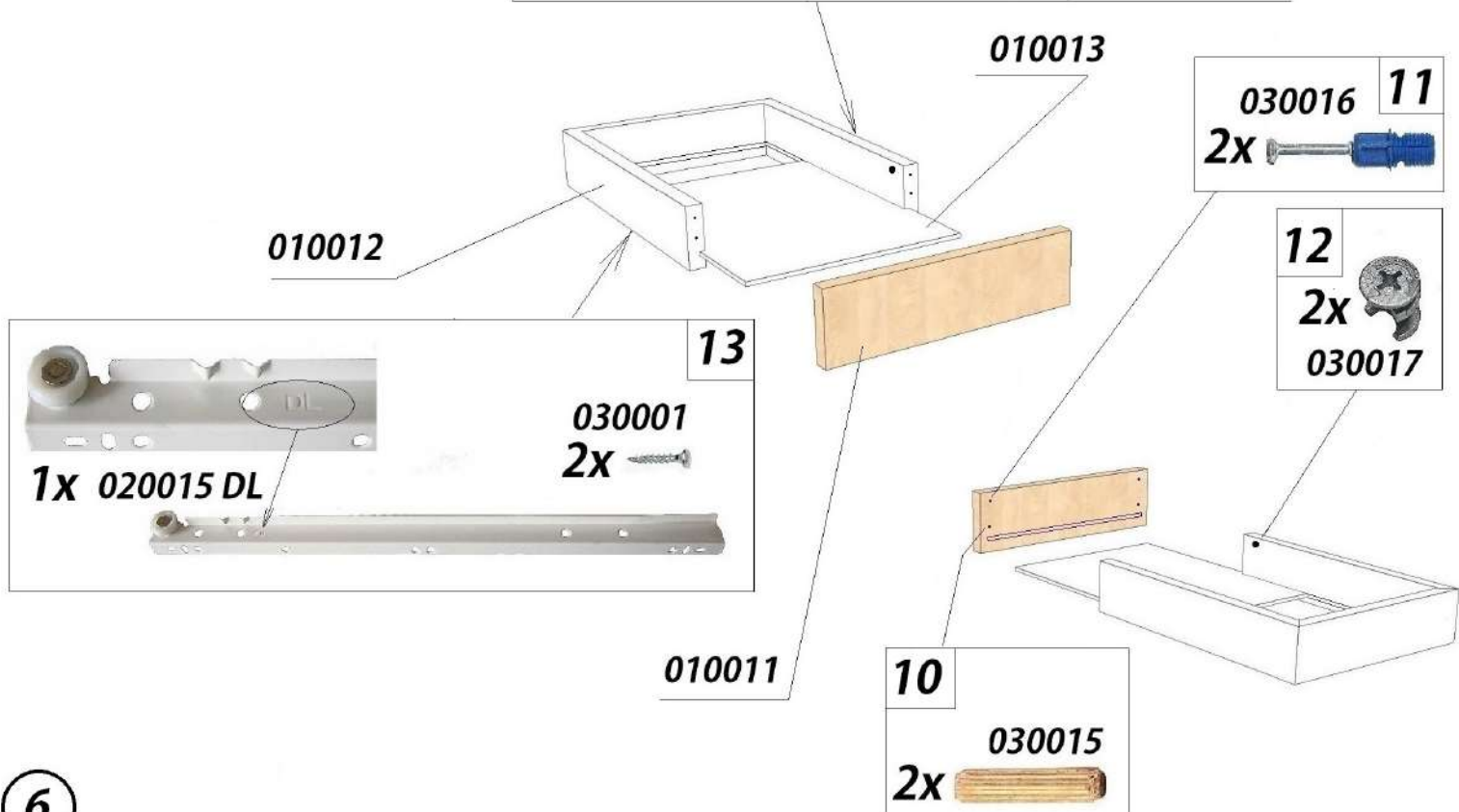
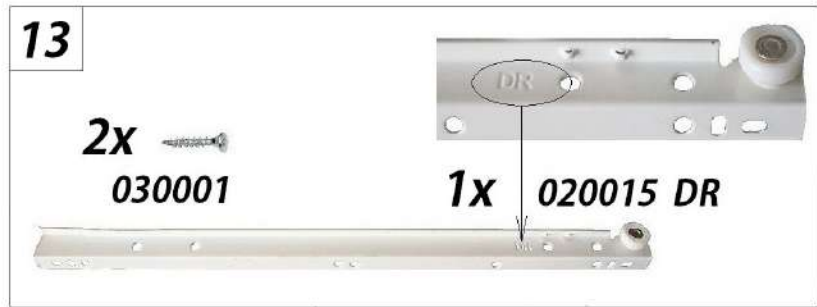
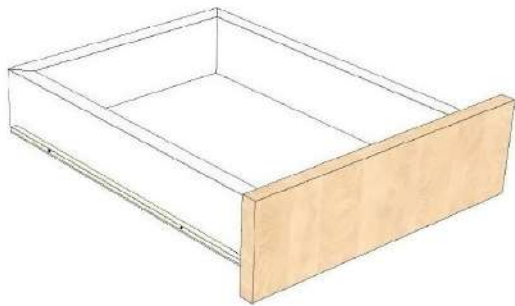
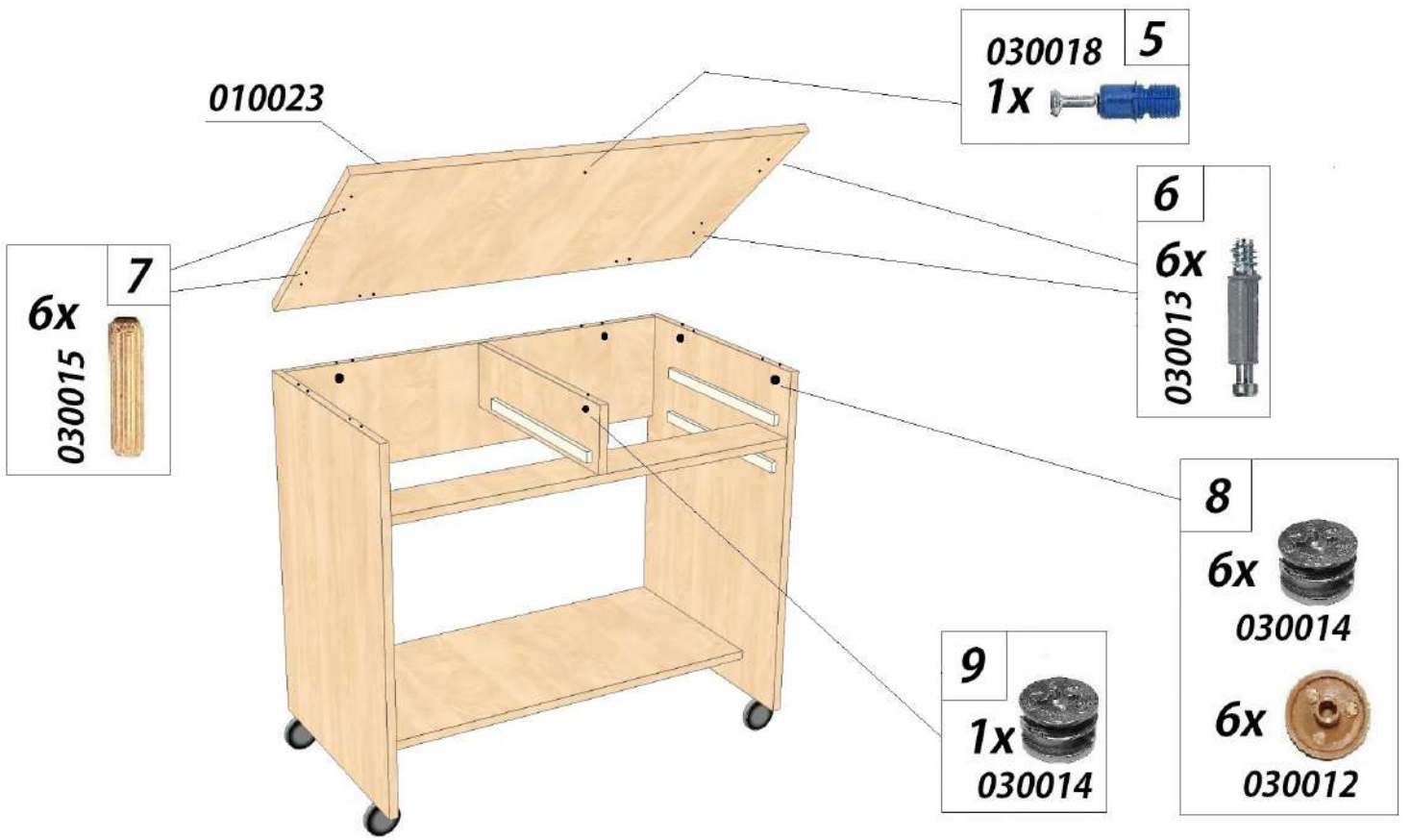

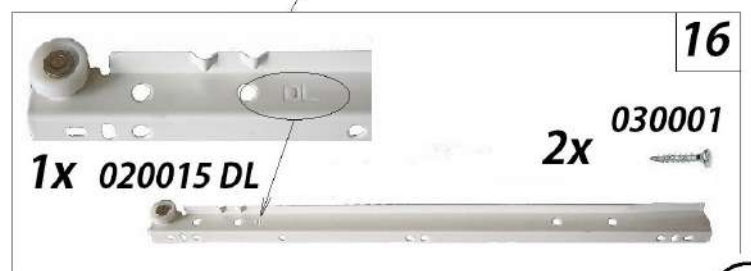
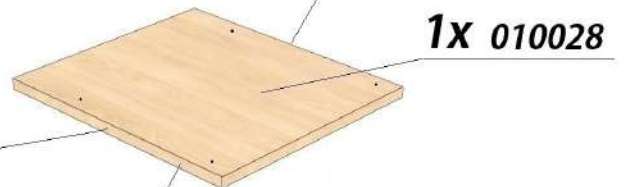
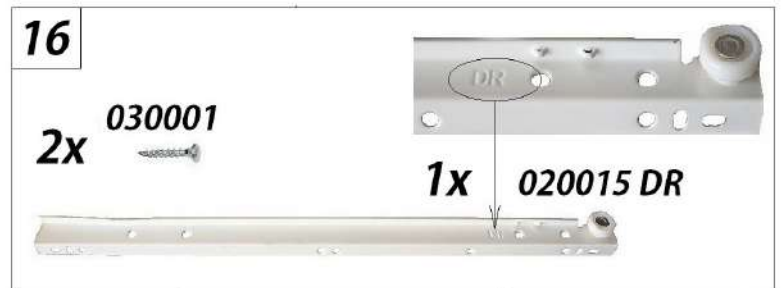
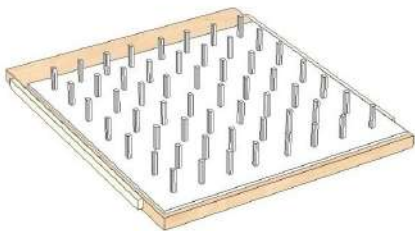
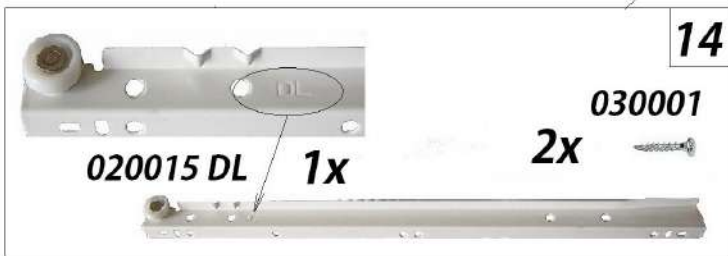
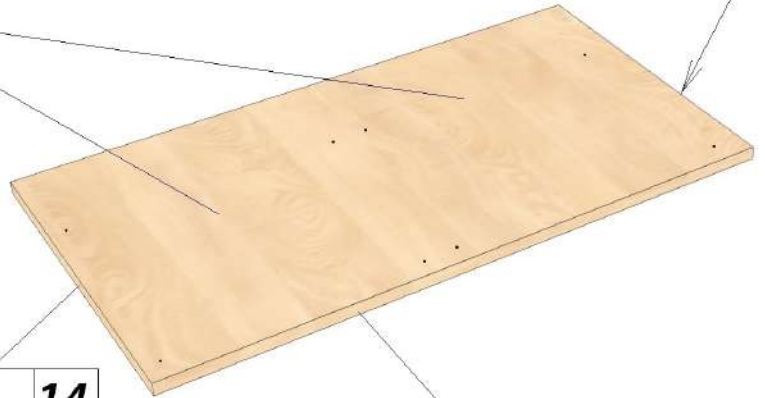
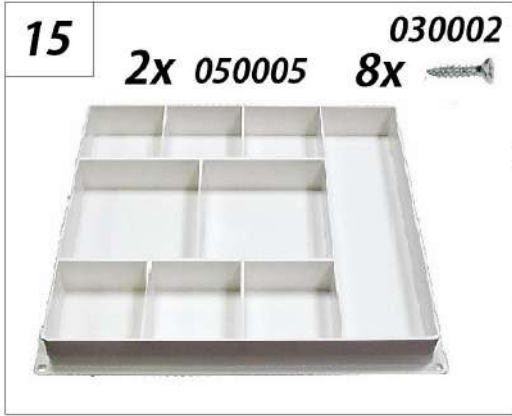
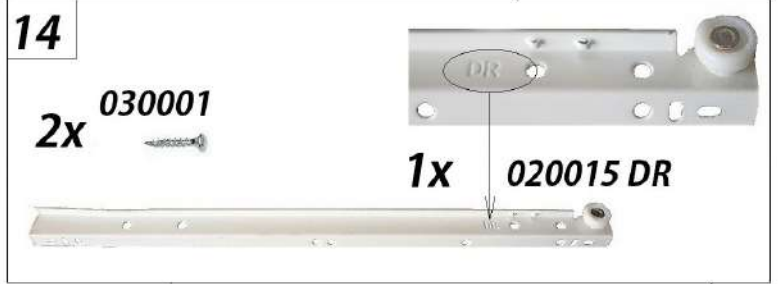
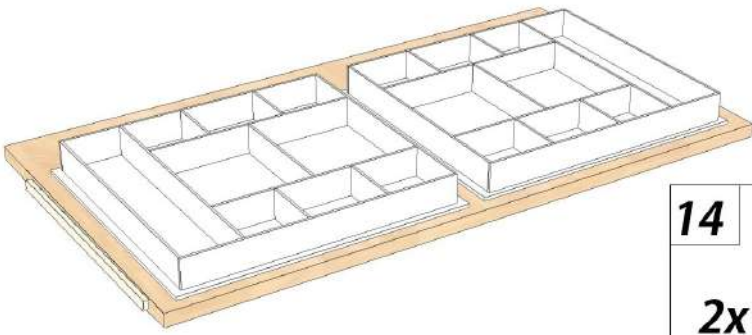



S 4 *

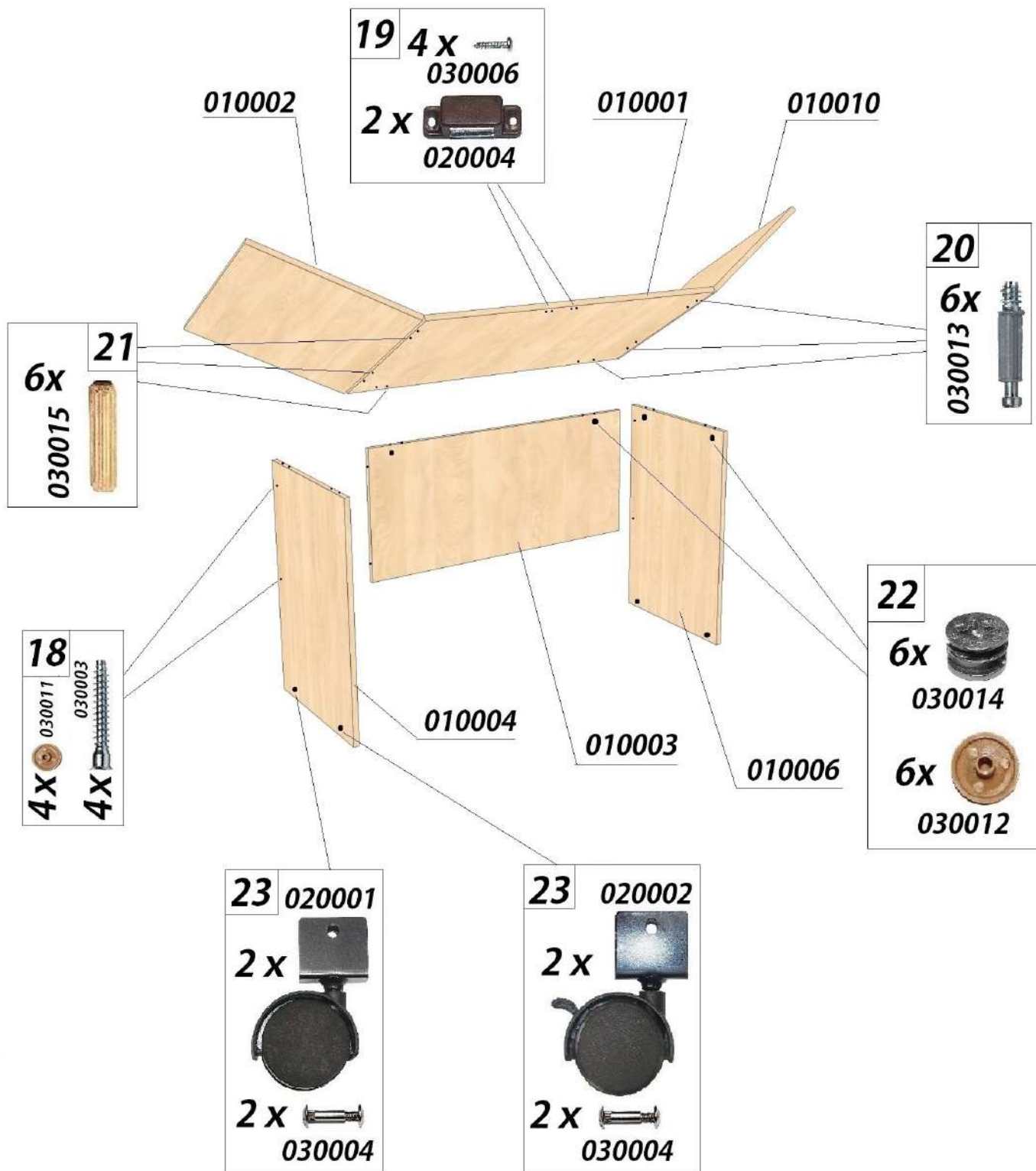

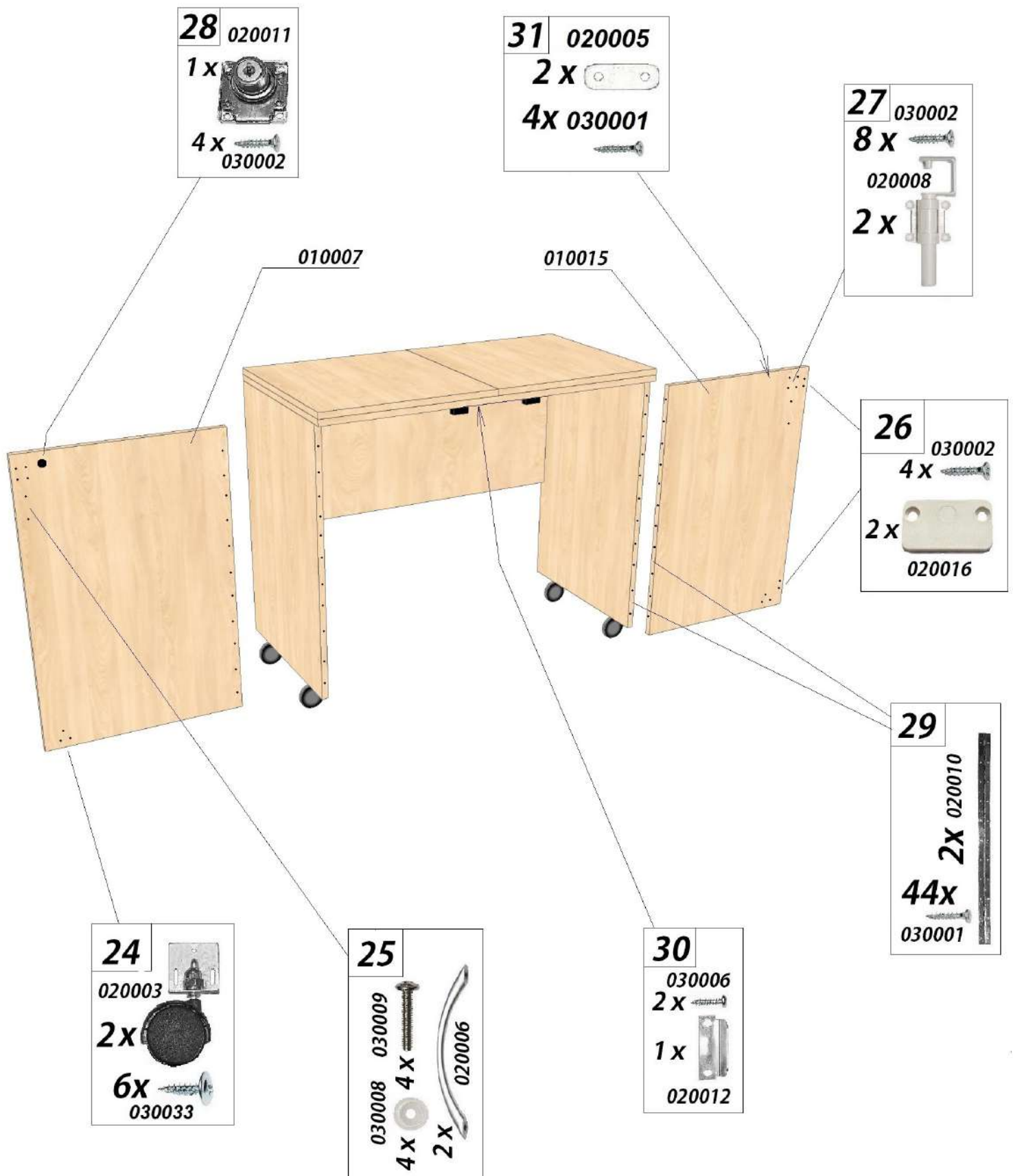



A

B

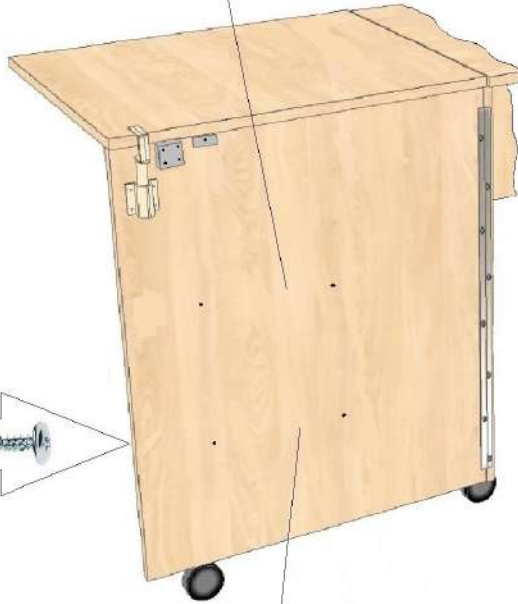
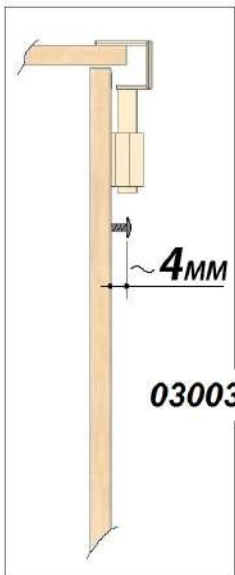



COMFORT 7+

36 12 x  030033



3 x 020019

35 8 x  030033



2 x 020019

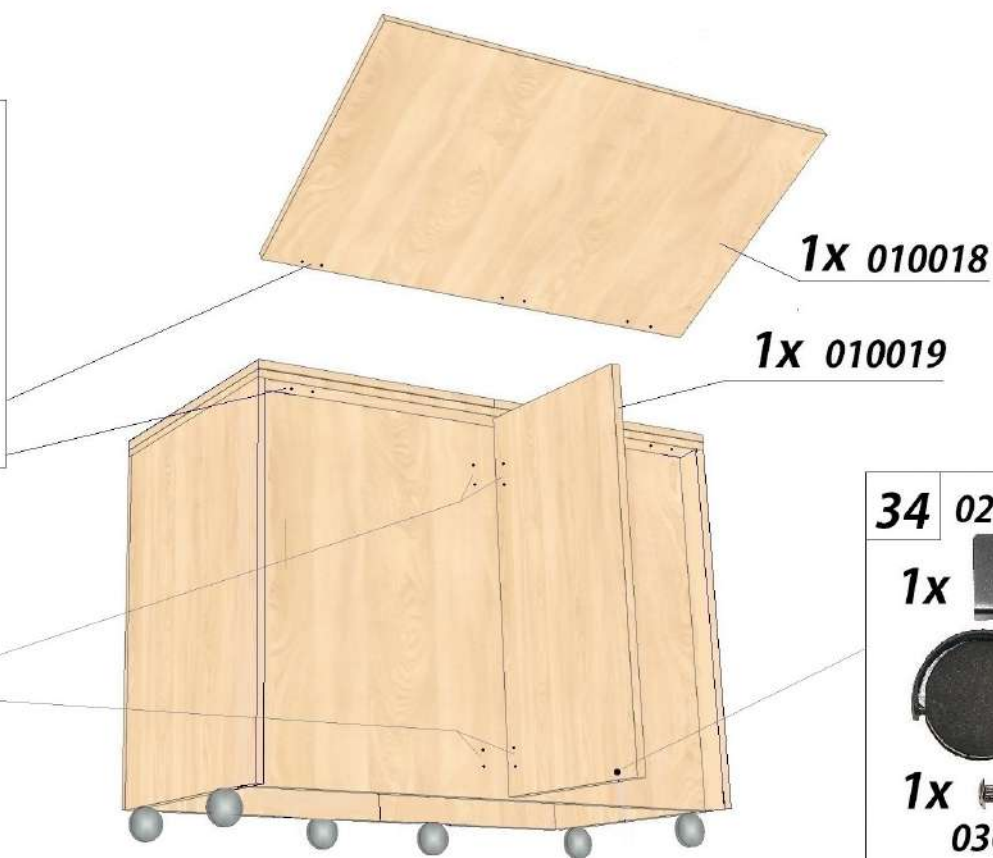

1x 

1x  030004

